









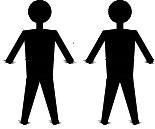

A	B	C	D	E	F	G	H
 Ø6x25 mm	 Ø6x30 mm	 Ø6x16 mm	 Ø8x16 mm	 Ø8x20 mm	 Ø4x8 mm	 P5	 P5
4 PCS	8 PCS	4 PCS	3 PCS	3 PCS	8 PCS	1 PC	1 PC
I							
 P6							
1 PC							

FIG. 1

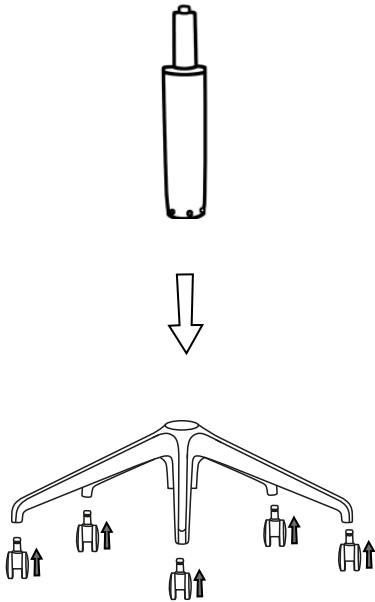


FIG. 2

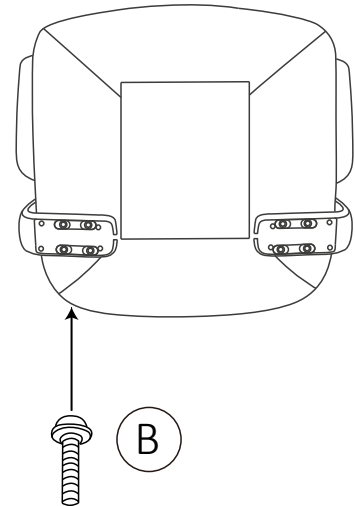


FIG. 3

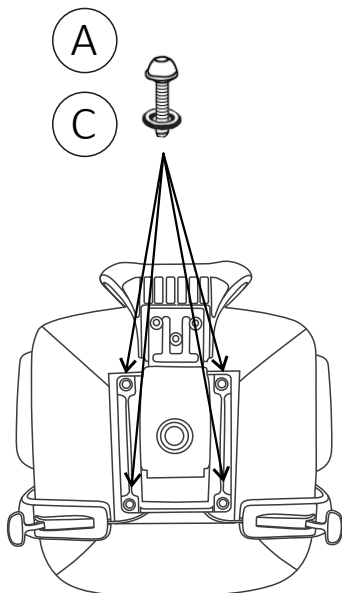
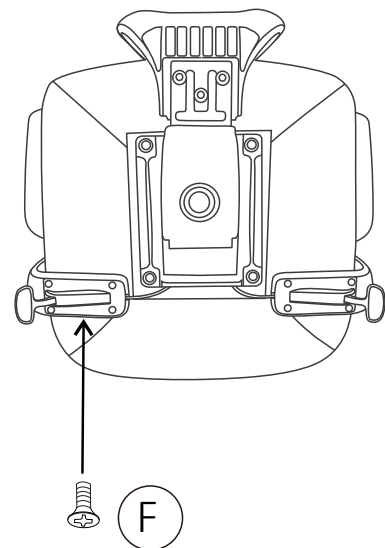


FIG. 4




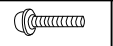


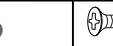



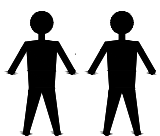
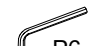
A	B	C	D	E	F	G	H
 Ø6x25 mm	 Ø6x30 mm	 Ø6x16 mm	 Ø8x16 mm	 Ø8x20 mm	 Ø4x8 mm	 P5	 P5
4 PCS	8 PCS	4 PCS	3 PCS	3 PCS	8 PCS	1 PC	1 PC
I							
 P6							
1 PC							

FIG.
5

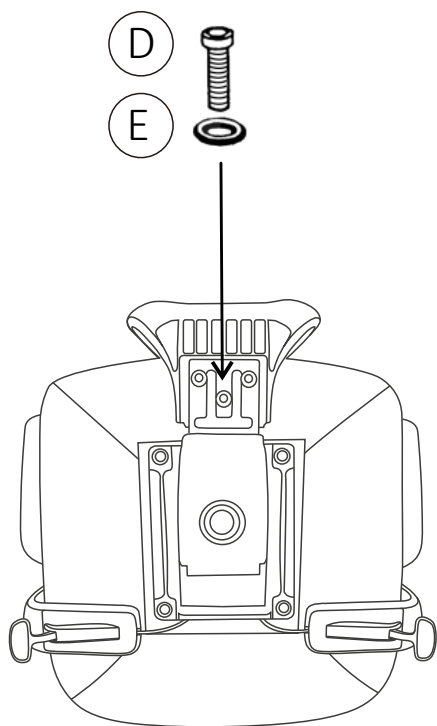
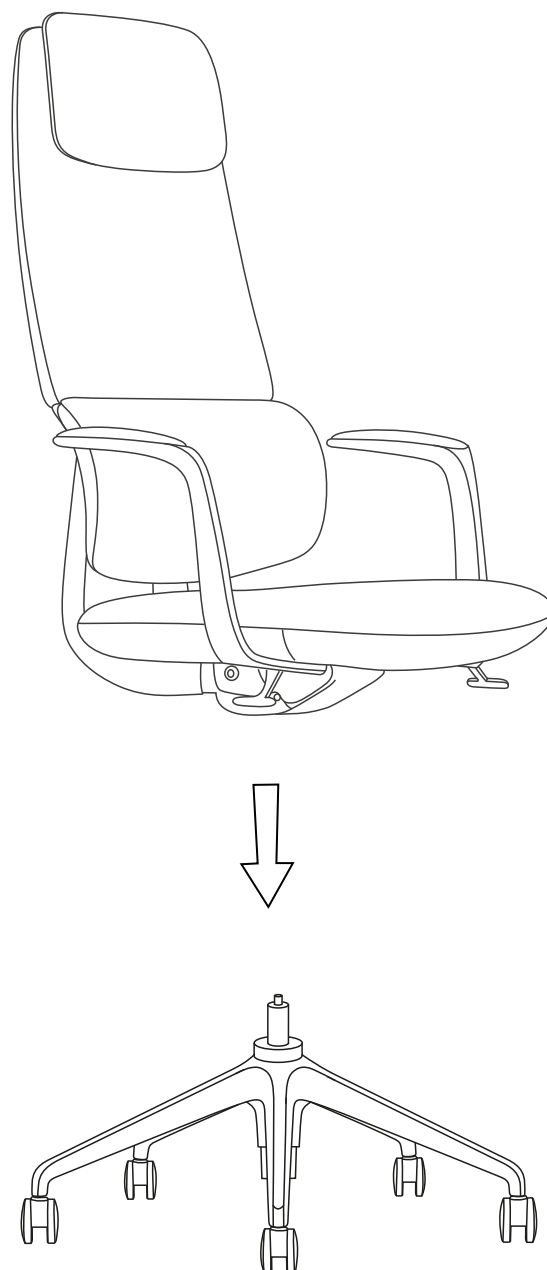


FIG.
6













A	B	C	D	E	F	G	H
 Ø6x25 mm	 Ø6x30 mm	 Ø6x16 mm	 Ø8x16 mm	 Ø8x20 mm	 Ø4x8 mm	 P5	 P5
4 PCS	8 PCS	4 PCS	3 PCS	3 PCS	8 PCS	1 PC	1 PC
I							
 P6							
1 PC							

FIG.
7

