







A	B	C	D	E	F
		 M8x20	 Ø17x8.5x1.5	 P5	 P4
1 PC	2 PCS	8 PCS	8 PCS	1 PC	1 PC







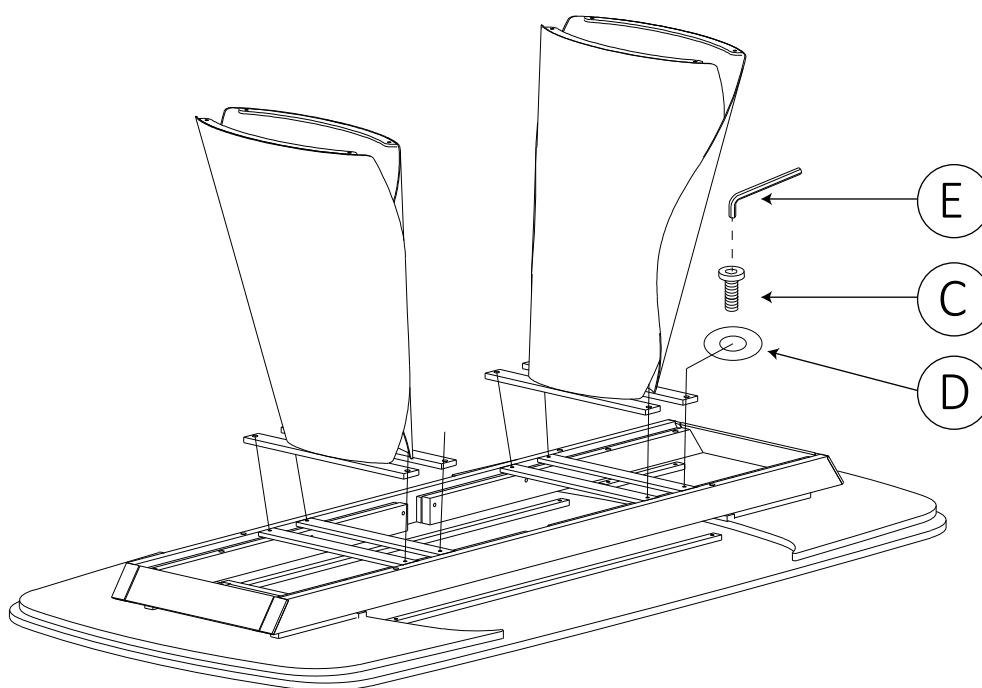

**FIG.**  
**1**



**FIG.**  
**2**



A	B	C	D	E	F
		 M8x20	 Ø17x8.5x1.5	 P5	 P4
1 PC	2 PCS	8 PCS	8 PCS	1 PC	1 PC

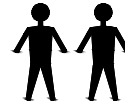



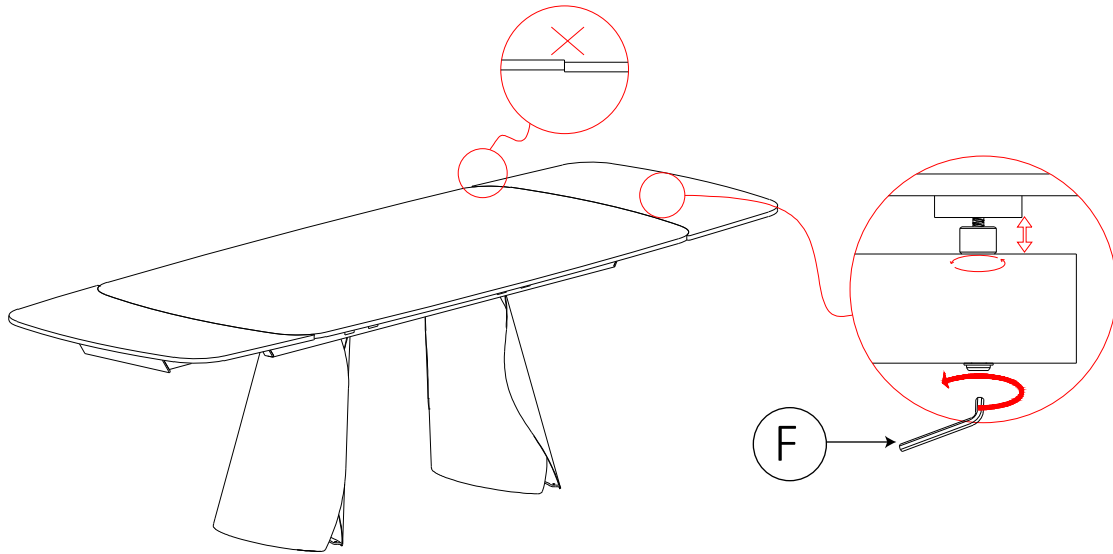

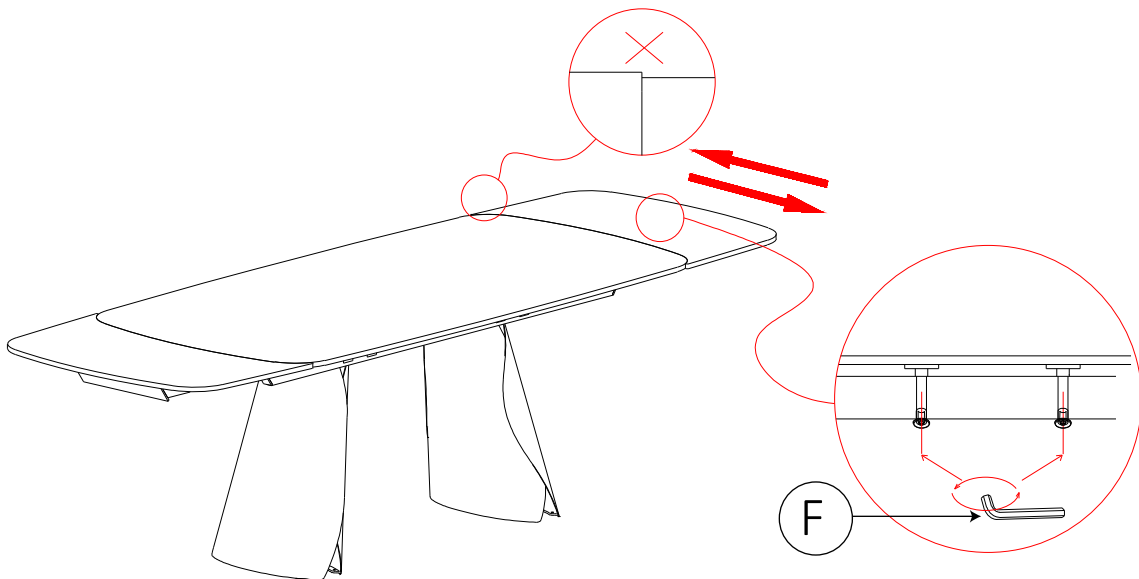

**FIG.**  
**3**



**FIG.**  
**4**



A	B	C	D	E	F
		 M8x20	 Ø17x8.5x1.5	 P5	 P4
1 PC	2 PCS	8 PCS	8 PCS	1 PC	1 PC



**FIG.**  
**5**

